

Isabella Junior

BACK-TO-WALL TOILET SUITE

K015 K015GB



Tornado Rimless



Ultra Quiet Flush

WELS 4 Star rated, 4.3L/3L (3.3L average flush)

- Gloss white finish
- Gloss White or Black Seat
- Tornado rimless ultra quiet flush
- Nano-Glaze protection
- Concealed pan for easy cleaning
- UF quick release, soft close single flap seat
- Anti vandal cistern option available
- Top or bottom inlets:
 - Left top inlet
 - Left or right bottom inlet
- Available as P-Trap or S-Trap
- Floor mounting pan screws included



CHECK GOODS THOROUGHLY BEFORE INSTALLATION

Installation of received goods that are damaged, warped or faulty will void warranty. Ensure all items meet your plumbing requirements.



PLEASE LEAVE THIS GUIDE WITH THE OWNER



Standard Cistern

Anti-Vandal Cistern

Parts List

Description	Item Code
Pan	K015-P
White Seat	UF015
Gloss Black Seat	UF015GB
Cistern	K015-C
Anti-Vandal Kit for Cistern	K015V-C
Flush Buttons (Standard Cistern)	200754
S-Trap 90-160 Connector Pipe	X022G
S-Trap 160-230 Connector Pipe	X011B
Pan Fixing Kit (Screws, Brackets, etc.)	200150
Cistern Bolts	200154
Rubber Donut	200160
R&T Top Inlet Valve	200129
R&T Outlet Valve	203100
Outlet Valve Washer	200828



Anti-Vandal Kit

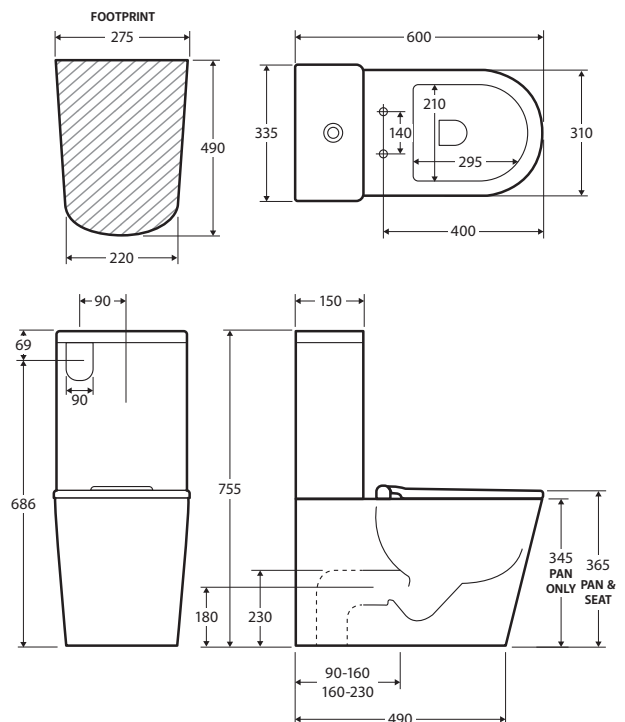

All installations should be carried out by a qualified tradesman in compliance with the National Plumbing & Drainage Code and any State or Local Authority Regulations, in accordance with AS/NZS 3500 series of standards and AS/NZA 6400. All measurements are in millimetres and are subject to change without notice. For ceramic products, please allow +/- 10 mm tolerance for manufacturing variance. Please refer to fienza.com.au for the latest product specification.

Cistern Installation

For anti-vandal cistern installation, please refer to instruction booklet within kit.

1. Parts required to mount cistern to pan.



2. Attach cistern bolts into pan. Tighten from underneath.



3. Tighten the basket nut and then fit the rubber donut.



4. Sit cistern onto pan.



5. Use supplied bolts to fasten cistern to pan.

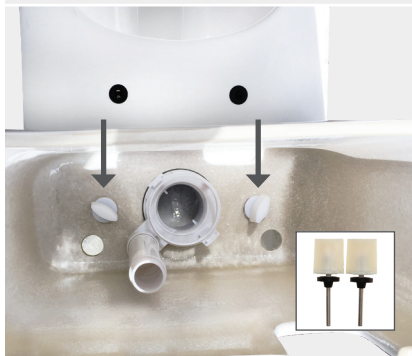

6. Attache the supplied flexi hose as pictured to suit your inlet setup.

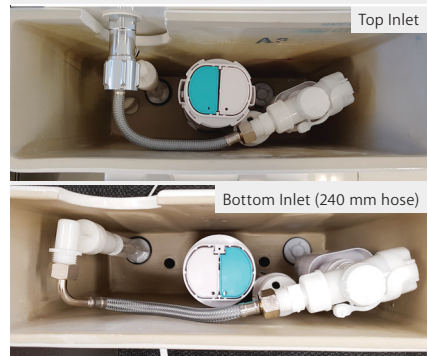

Standard R&T cistern

S-Trap Installation

1. The S-pipe should be put into position and cut to suit your set out, then attached to the wall using the supplied threaded fitting. This clips to the back of the pipe and has a mounting plate which can be attached to the wall using screws (not included).
2. Push the pan hard into position to ensure the ceramic outlet is pushed into the S-pipe until a secure fitting is reached.

PLEASE DO NOT SILICONE PAN TO FLOOR UNTIL TOILET HAS BEEN CHECKED FOR LEAKS.

All installations should be carried out by a qualified tradesman in compliance with the National Plumbing & Drainage Code and any State or Local Authority Regulations, in accordance with AS/NZS 3500 series of standards and AS/NZA 6400. All measurements are in millimetres and are subject to change without notice. For ceramic products, please allow +/- 10 mm tolerance for manufacturing variance. Please refer to fienza.com.au for the latest product specification.

Seat Installation

1. Take care not to open the lid past 105° before it is fixed to the toilet pan.

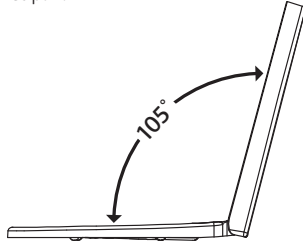

2. Remove the screw from the hinge plug, taking care to keep the brass nut inside the plug. Arrange the components as shown in the diagram. Screw into place. The fixing bracket in the plug will automatically move into the horizontal position for a secure fit.

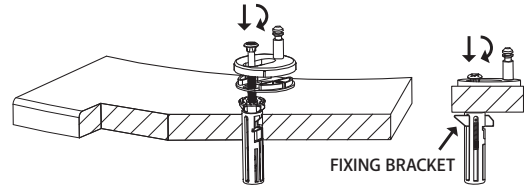

3. Push toilet seat onto fixings.

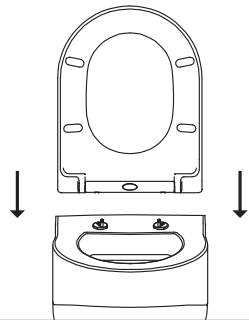

4. Adjust to fit ceramic well.

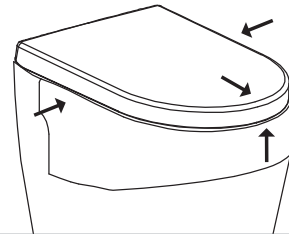

5. Push button and lift seat straight up to remove.

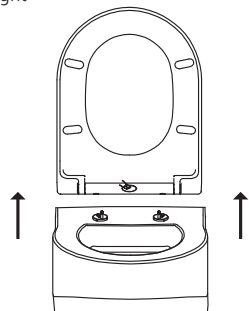

6. Tighten the screws.

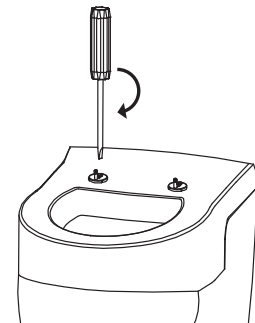

7. Fix hinge covers over hinges.

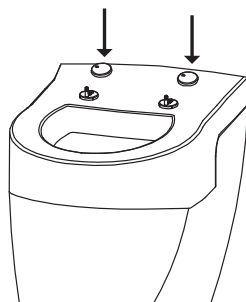

8. Replace the seat.

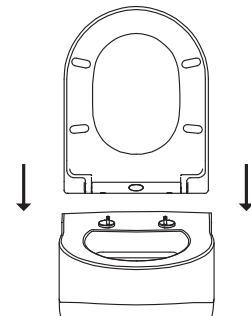

All installations should be carried out by a qualified tradesman in compliance with the National Plumbing & Drainage Code and any State or Local Authority Regulations, in accordance with AS/NZS 3500 series of standards and AS/NZA 6400. All measurements are in millimetres and are subject to change without notice. For ceramic products, please allow +/- 10 mm tolerance for manufacturing variance. Please refer to fienza.com.au for the latest product specification.

R&T® Cistern



WARNING

Do not use chlorine/chemical sanitisers in the cistern tank. Such use may result in damage to tank components and will void the product warranty.

Inlet Valve Service

1. Water Level Adjustment

Turn screw to raise/lower the float

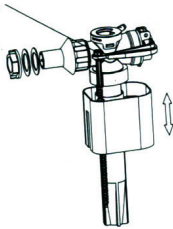

2. Cleaning the Diaphragm

It is possible for dirt/debris to prevent the valve shutting off. To remedy this the diaphragm may be cleaned as follows:

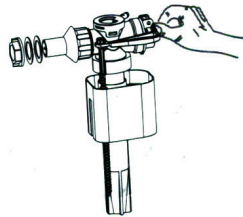

1. Unclip the float arm from the adjustment screw
2. Twist the plastic top-assembly firmly anti-clockwise and remove it from the valve body
3. Inspect both rubber diaphragm and valve seat
4. Rinse under running water to remove debris
5. Re-assemble in reverse order

Outlet Valve Service

Removal

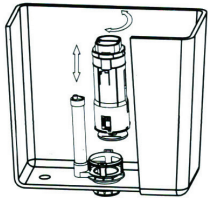

Valve may be removed for service - twist to unlock

Assembly

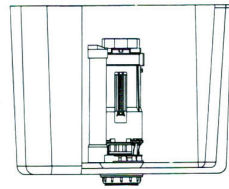

Hoses are not shown on the diagram

Push Button Rod Settings

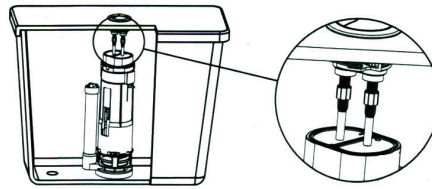

Button rods must be just clear of the valve pads

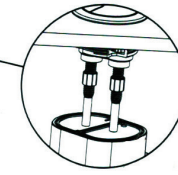

Button rods can be adjusted by screwing up or down

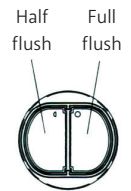

Ensure that buttons match valve pads

Half Flush Adjustment

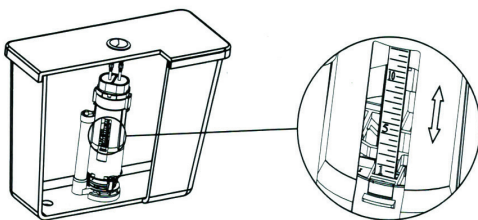

Half flush volume can be adjusted by moving the side float up or down.
Moving the float DOWN increases the flush.
Moving the float UP decreases the flush.

Full Flush Adjustment

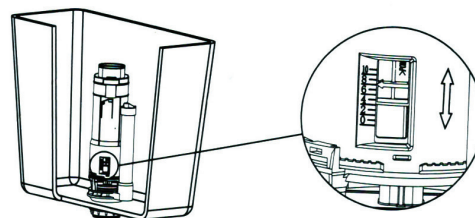

Full flush volume can be adjusted by changing the residual water level in the cistern.
Move the adjuster DOWN to increase the volume.
Move the adjuster UP to decrease the volume.

All installations should be carried out by a qualified tradesman in compliance with the National Plumbing & Drainage Code and any State or Local Authority Regulations, in accordance with AS/NZS 3500 series of standards and AS/NZS 6400. All measurements are in millimetres and are subject to change without notice. For ceramic products, please allow +/- 10 mm tolerance for manufacturing variance. Please refer to fienza.com.au for the latest product specification.

Warranties

Residential Warranty Periods

Applies to domestic uses and applications of Fienza® products, such as private dwellings and retirement villages.

Commercial Warranty Periods

Applies to commercial uses and applications of Fienza® products, including, but not limited to: commercial food premises such as restaurants; commercial accommodation such as hotels; hospitals and healthcare facilities; public amenities; and industrial, laboratory and manufacturing facilities.

TOILETS*		*Excludes parts subject to wear and tear such as rubber seals.
Range / Component	Residential	Commercial
Vitreous China	5 years replacement parts or product, 1 year labour	3 years replacement parts or product, 1 year labour
R&T Cisterns (Tanks & Frames)	5 years replacement parts or product, 1 year labour	5 years replacement parts or product, 1 year labour
R&T Cisterns (Valves)	3 years replacement parts or product, 1 year labour	1 year replacement parts or product, 1 year labour
R&T Flush Button Plates	2 years replacement parts or product	1 year replacement parts or product
Geberit Cisterns (Tanks & Frames)	15 years replacement parts or product	15 years replacement parts or product
Geberit Cisterns (Valves)	3 years replacement parts or product, 1 year labour	3 years replacement parts or product, 1 year labour
Geberit Flush Button Plates	3 years replacement parts or product	3 years replacement parts or product
Seats, Accessories & Spare Parts	1 year replacement parts or product	1 year replacement parts or product

Australian Consumer Law

Our goods come with guarantees that cannot be excluded under the Australian Consumer Law. You are entitled to a replacement or refund for a major failure and compensation for any other reasonably foreseeable loss or damage. You are also entitled to have the goods repaired or replaced if the goods fail to be of acceptable quality and the failure does not amount to a major failure.

Fienza Pty Ltd reserves the right to make changes in product characteristics, packaging or availability at any time without notice. Please visit www.fienza.com.au for the latest information.

Warranty Conditions

- Installation has been carried out by a licensed plumber in accordance with the plumbing code of Australia.
- All maintenance and adjustments to the product after the installation have been carried out by a licensed plumber.
- No additives have been introduced into the cistern tank.
- Only mild household detergents and soft (non-abrasive) cloth has been used to clean the product.
- All goods of substandard quality manufacture (excluding imperfections permitted within AS1976 - Vitreous China used in Sanitary Applications) will be credited or replaced by Fienza when advised within the warranty period, subject to prior inspection and agreement.
- Proof of purchase is required for warranty claims.

Warranty Limitations

To the extent permitted under the Trade Practices Act and other relevant legislation, Fienza's liability is limited to:

- The cost of replacing the goods, or
- The cost of obtaining equivalent goods, or
- The cost of having the goods repaired.
- Fienza is not responsible for any lack of operation or performance of goods (or any loss or damage) where goods are used or adapted for use with other goods not supplied by Fienza.
- It is the responsibility of the customer and installer before installation to ensure that all components are correct and free of obvious visible faults.
- Fienza is not responsible for the labour and rectification costs incurred in the above circumstance.

Conditions for On-Site Warranty Service Calls

Fienza will charge a service fee for each visit to an installation by its technician where it is determined that the fault is due to poorly executed or unlicensed installation work or where the product is not a genuine Fienza product or where the product is outside the warranty period. This may be paid in advance by credit card over the phone to a Fienza technician attending the site and will be refunded if the Fienza product is found to be at fault.

For warranty support, please contact Fienza

15 Walter Cres, Lawnton QLD 4501 PO Box 5381, Brendale QLD 4500
P 07 3490 6700 **F** 07 3490 6719 **E** help@fienza.com.au ABN 76 136 411 311

